

## Features

- Adopt high quality 3535 LED
- High brightness of single bar
- Secondary optical lens for uniform light
- Stable and reliable performance, easy installation
- 5 years Warranty

## Application

Suitable for edge-lit double-sided lightbox with depth of 8-30cm and width of 3m.

## Installation

Fix by self adhesive tape or screws



## Specification

Model No.	Light Color	Color Temperature (K)	Beam Angle	Typical Luminous Flux value(lm/pcs)	Ra	Efficacy (lm/W)	Voltage (V DC)	Power (W/pcs)
BPS300-0205	W	6500	8*15°	810	70+	90	24	10.8
BPS300-0510	W	6500	8*15°	1620	70+	90	24	21.6

## Other Parameters

Model No.	LED Quantity/pc	Product Size L*W*H(mm)	Max Run (Single Feed)(pcs)	Working Temperature	Storage Temperature
BPS300-0205	5	250*25*13.5	4	-20~+60°C	-20~+70°C
BPS300-0510	10	480*25*13.5	3	-20~+60°C	-20~+70°C

**NOTE:**

1. Test environment temperature : 25±2°C.
2. The above data is typical values. The actual data of each single product may differ from the typical values. The data is subject to change without notice.
3. Luminous flux is tested when lighting on with the single color.
4. Different color temperature will make luminous flux different.
5. The Luminous flux and Power tolerance within ±10%.

## Profile Drawings

Unit:mm[inch]

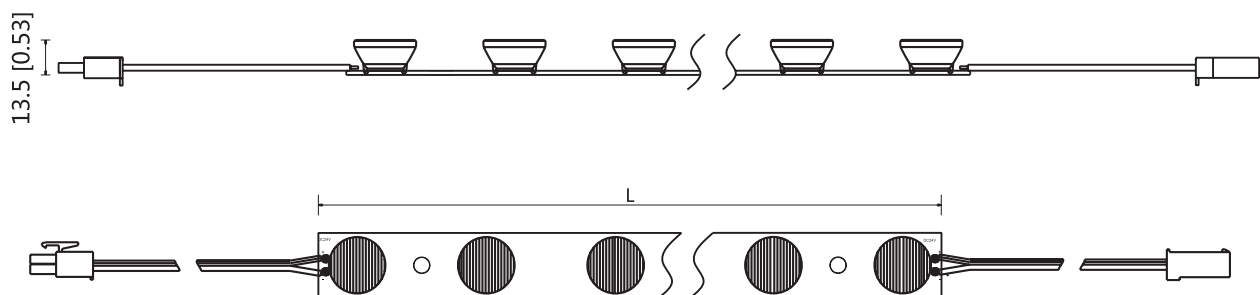

**NOTE:**

AMPR terminals are used at both ends  
For detailed drawing, please consult sales rep.



Luminous Intensity Distribution Diagram

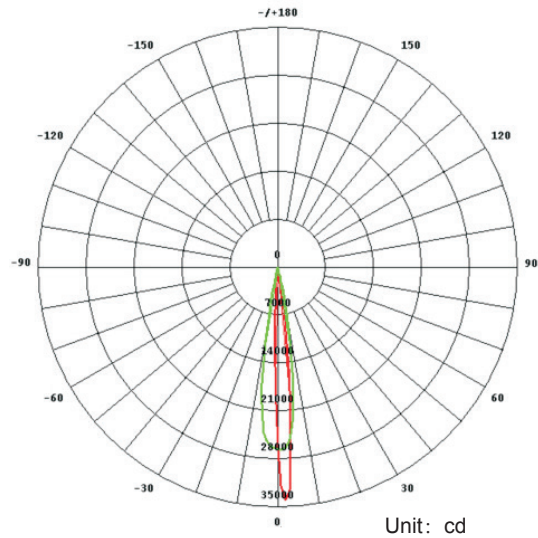

AVERAGE BEAM ANGLE(50%): 12.5°  
 — C0/180, 7.2°  
 — C90/270, 17.9°

Average Illumination

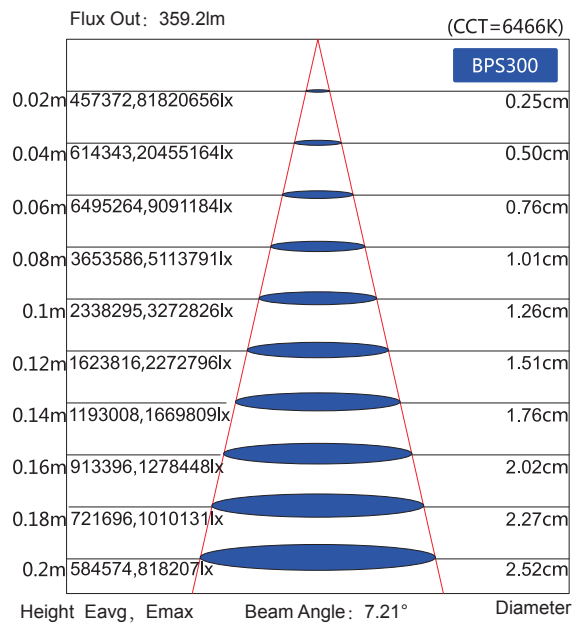

Note: The above two figures are tested with the sample BPS300 at 6466K, for other data, please consult sales rep.



packing

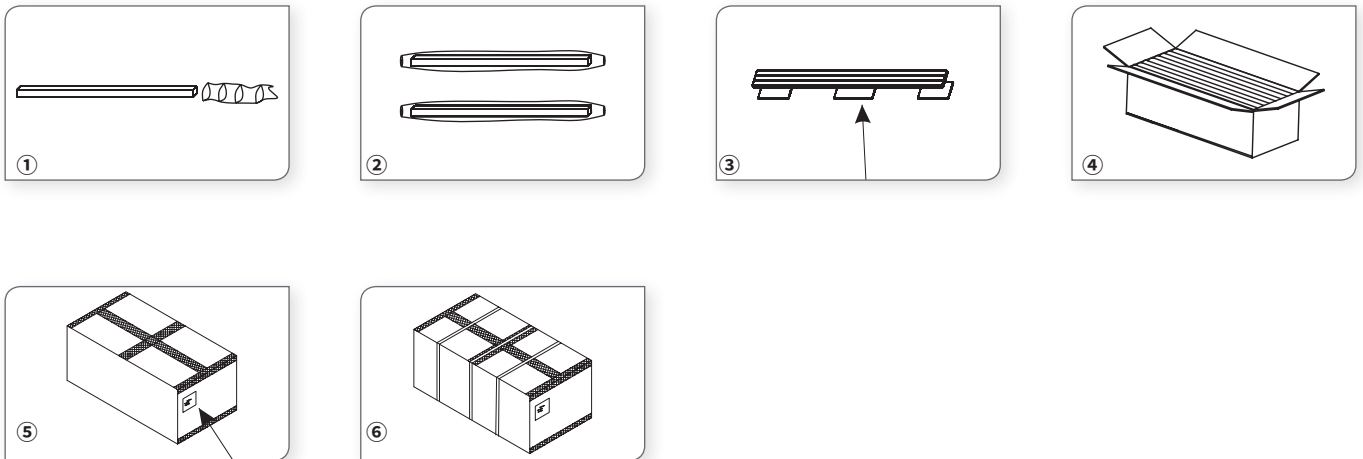

1. Put the product into PE bag.
2. Seal the bag in two ends and label it.
3. Separate the product layer by layer with foam.
4. Put the product into carton box.
5. Seal and label the box.
6. Use packing belt to pack. Add edge protectors if necessary.

Packaging information

Model No.	Product Size L*W*H(mm)	Carton Size(mm)	Pcs/carton	Net Weight(kg)	Gross Weight(kg)
BPS300-0205	250*25*13.5	390*390*325	156	7.65(1±10%)	9.25(1±10%)
BPS300-0510	480*25*13.5	685*295*275	80	7.75(1±10%)	9.55(1±10%)

Note:

The above quantity and weight are only for the illustrated packaging method. There will be differences in the quantity and weight with other packaging methods.



## Installation

### 1.Connection Diagram

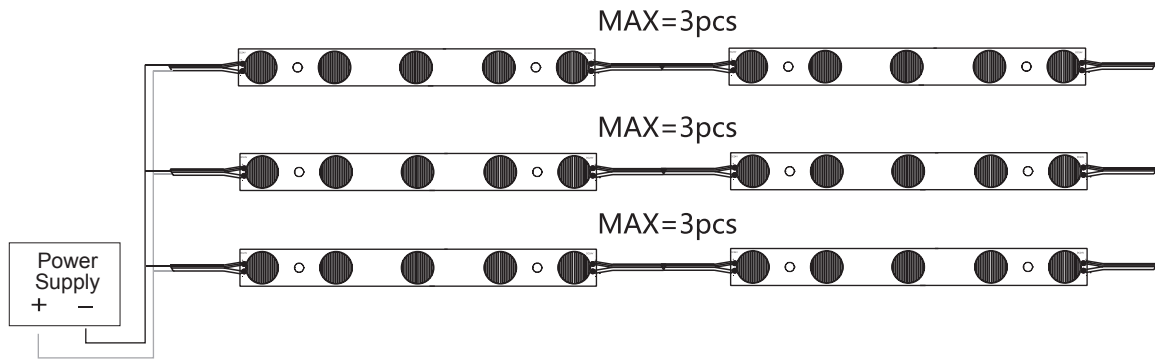

### 2.Installation Reference

Model No	Lightbox	Lighting Mode	Surface Material	Width (m)	Depth (cm)	Watt Density (W/ m <sup>2</sup> )	Density (PCS/2m)	Illumination (Lux)	Evennes
BPS300	Double-sided Lightbox	Double Side	White Soft Film	2	10	43.2	1*2	1831-2210	0.82
				2.5	10	43.2	1*2	1215-1891	0.64
				2	10	43.2	1*2	897-1687	0.53

**Note:**

The density is within a light box of 1 square meter. PCS/m indicates the product quantity installed on single side, and PCS/2m indicates the quantity of double-sided installation.

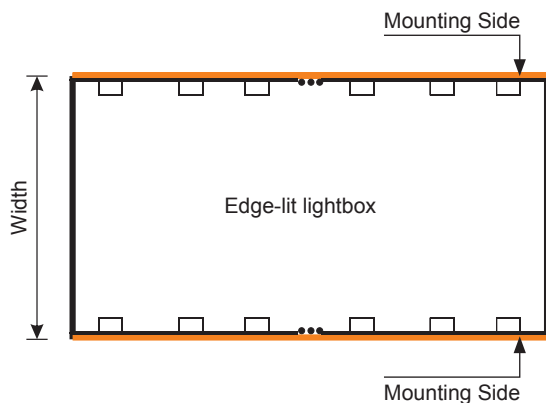

**Note:**

- The density refers to product quantities installed on the mounting side, and "3\*2" refers to 2 mounting sides and each side with 3pcs.
- The spacing means centre spacing of the product, see the left.
- The above products use porcelain whiteboard.



### 3.Products and Tools

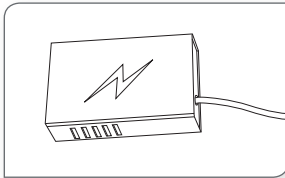

LED power supply

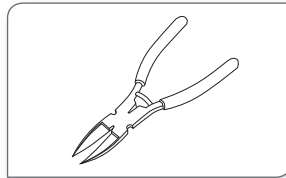

Diagonal pliers

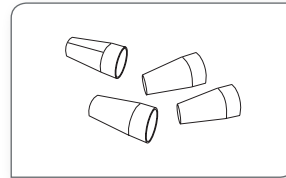

Connection Terminals

## Attentions before installation

- Before installation, check that the product parameters are consistent with the requirements (Seeing product specifications or product labels)
- Load voltage, current, power and power supply should be matched with the product.
- Follow the instructions of wiring diagram (first connect the load and then the power supply) to avoid short circuit.
- Make sure the correct connection of positive and negative poles between products and power supply. Otherwise, the light will not be on.
- Make sure the power cord firmly screwed into the terminal and it should not be pulled out by hands.
- The terminal should have insulation,waterproof and anti-corrosive treatment.
- Please take and use the product gently to avoid damage.

## Common Faults and Troubleshoot

Quick Guide		
Problems	Reasons	Solutions
All LEDs can not light on.	No electric supply.	Power on
	Automatic power protection from the open or short circuit in output of the power supply.	Fix the short circuit problem.
	Wrong connection of power supply.	
LEDs can not light on partly.	Some switching mode power supplies are not powered.	Check the power supply system to fix it.
	Power supply line error.	
	Mistaken wire connection of some of products	Correctly connection
Brightness of LED is inconsistent tor insufficient.	Power overloaded.	Replace with more powerful power
	Power supply circuit excessive consumption.	Make sure the working voltage of the product within $\pm 5\%$ of standard voltage, or keep balance by circuit power consumption.
	Excessive quantities in series connection of the product	Reduce the quantities of the product in series connection to meet requirement.
LED flicker.	Connection point fault.	Remove bad connection point.
	Switching power supply failure.	Replace a new power supply.
	Wrong Installation or use of products	Please follow the instructions

### Warning

- Do not disassemble or retrofit the light. Do not touch the surface of the light with a sharp object.
- Do not do live-line working during installation,especially for high voltage product.
- Do not use any organic chemical solvents.
- Use neutral glass adhesive to fix this product and it needs to be dried 4 hours in the open environment after operation.
- Treat the ends and the circuit connection points that are not connected to the main line with insulation,waterproof, and anti-corrosion in the installation.
- Use 18AWG (0.75mm<sup>2</sup> cross-sectional area) or thicker core wire to avoid adverse consequences caused by overheating, if the power cable need to lengthen.
- Make sure the input voltage meets the requirements and lines are connected correctly before lighting on.
- This product is for signage, and do not use as general lighting.
- Series connection within the max run.
- The length of the power cable between the power supply and the led strip should not exceed 2 meters.Otherwise, large circuit loss will lead to inconsistent brightness.
- Installation, maintenance and repair should be operated by a qualified technician.



## Statements and Recycling

### Statements:

Repair should be operated by a qualified technician, if the external circuit or main line of this product is damaged.  
The parameters given in this manual are typical values and for reference only.  
All illustrations and drawings in this manual are for reference.  
This product is subject to change without notice.

### Recycling:

LED lighting products belongs to electronic products, please do recycling treatment according to the relevant WEEE directives.